

APPENDIX
G2.2 MAX

“MAXIMA” STANDARD STAND CONSTRUCTION: SAMPLES & PACKAGES

Address: 129223, Russia, Moscow, Prospect Mira, VDNH, tel./fax: +7 (495) 748-37-72
 internet: www.tech-apk.ru E-mail: kev@vvcentre.ru

“MAXIMA” is standard of premium class. It is one of the new trends in the exhibition industry introduced by the German Octanorm prefabricated stand system. The basic element of the system used for a variable exhibition stand constructions is a square-shaped supporting profile with dimensions 80 x 80 mm. Height of walls - 2,5 m, height of front parts (opened) - 3,0 m. Colour of an fascia panel inscription is black by default. The packages of furnishing for the “MAXIMA” are completed the same as for standard “Octanorm” stands.

9 - 11 sq. m booth

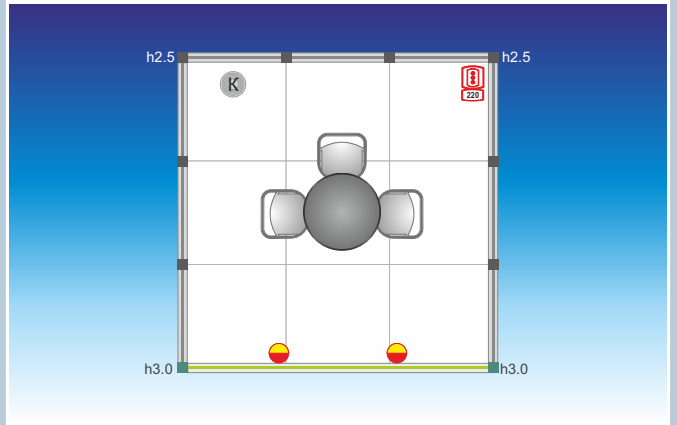

12 - 14 sq. m booth

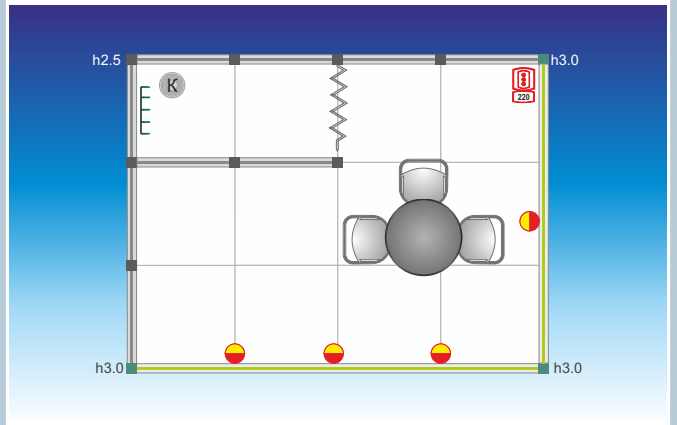

15 - 17 sq. m booth

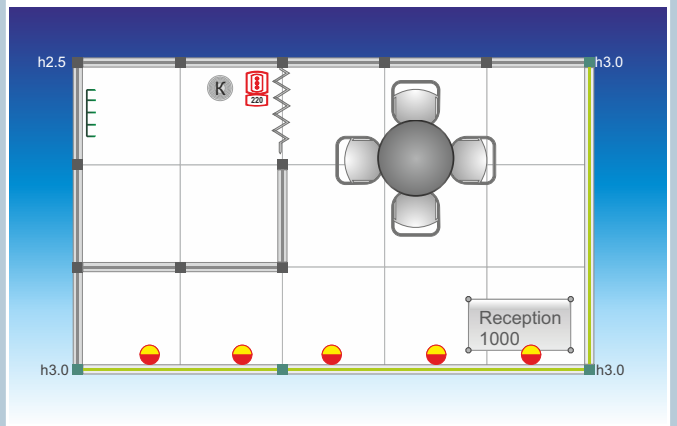

Standard packages for “MAXIMA”

	Carpet cover	Wall element h=2,5m	Fascia panel on height 3,0m	Sliding door	Chair	Table d75 cm, h75 cm	Coat Rack, wall-mounted	Wastebasket	Information counter h=1,0m, Octanorm	Spot light	Socket 220V 1,0 kW
9 - 11 sq. m booth	⊙	⊙	⊙	○	3 pcs	1 pc	○	1 pc	○	2 pcs.	1 pc
12 - 14 sq. m booth	⊙	⊙	⊙	1 pc	3 pcs	1 pc	1 pc	1 pc	○	4 pcs.	1 pc
15 - 17 sq. m booth	⊙	⊙	⊙	1 pc	4 pcs	1 pc	1 pc	1 pc	1 pc	5 pcs.	1 pc

⊙ The equipment is present at the stand
 ○ The equipment is missing on the stand

If you are not satisfied with the standard layout or the size of your stand exceeds 35 sq.m, fill in the Form B6 please

SYMBOLS

- Fascia Panel H=0,3m
- Wall Panels H=2,5m
- Office Table, Round D=80cm., H=75cm
- Chair
- Coat rack, Wall mounted
- Socket 220V, 1000W
- Waist Basket
- Spot light (100W)

A

B

C

D

E

G
MAX

APPENDIX
G2.2 MAX

“MAXIMA” STANDARD STAND CONSTRUCTION: SAMPLES & PACKAGES

Address: 129223, Russia, Moscow, Prospect Mira, VDNH, tel./fax: +7 (495) 748-37-72
 internet: www.tech-apk.ru E-mail: kev@vvcentre.ru

“MAXIMA” is standard of premium class. It is one of the new trends in the exhibition industry introduced by the German Octanorm prefabricated stand system. The basic element of the system used for a variable exhibition stand constructions is a square-shaped supporting profile with dimensions 80 x 80 mm. Height of walls - 2,5 m, height of front parts (opened) - 3,0 m. Colour of an fascia panel inscription is black by default. The packages of furnishing for the “MAXIMA” are completed the same as for standard “Octanorm” stands.

18 - 23 sq. m booth

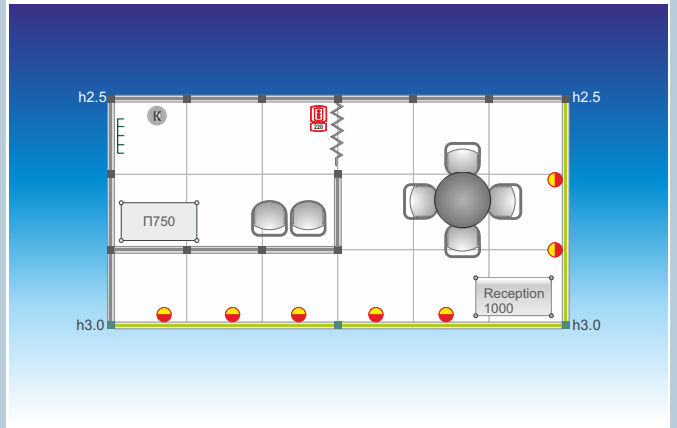

24 - 29 sq. m booth

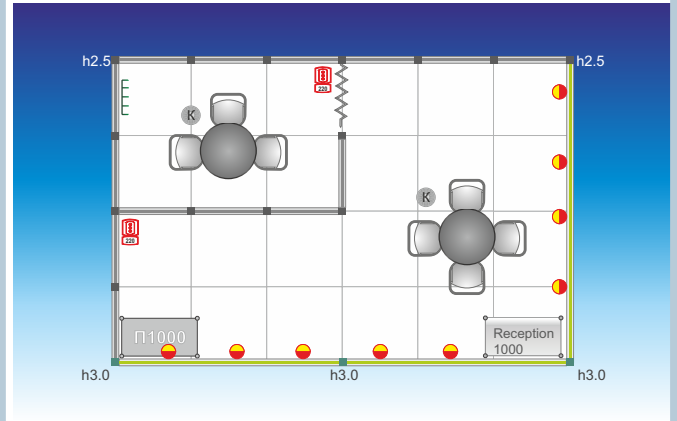

30 - 35 sq. m booth

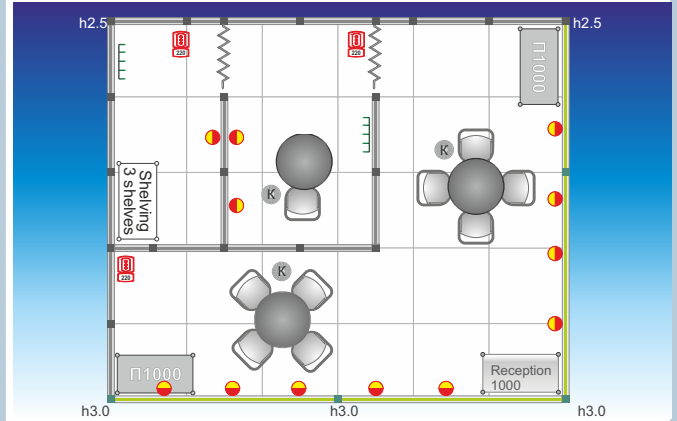
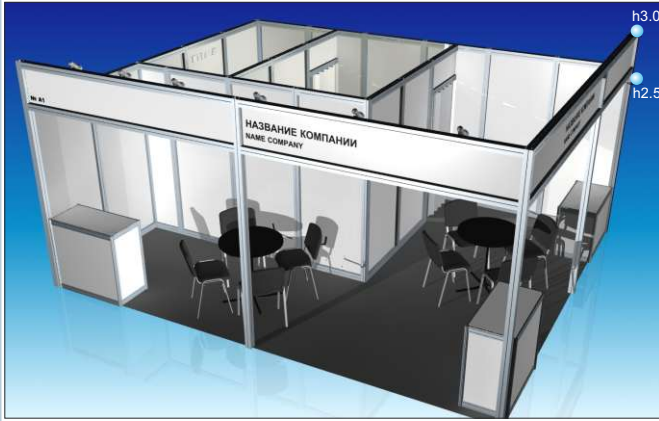

Standard packages for “MAXIMA”

	Carpet cover	Wall element h=2,5m	Fascia panel on height 2,5m	Sliding door	Chair	Table d=75 cm, h=75 cm	Coat Rack, wall-mounted	Wastebasket	Information counter h=1,0m, Octanorm	Podium table 0,5x1,0 h=1,0 m, 75cm	Shelving 1,0x0,5 h=2,0 m, 3 shelves	Spot light	Socket 220V 1,0 kW
18- 23 sq. m booth	⊙	⊙	⊙	1 pc	6 pcs	1 pc	1 pc	1 pc	1 pc	○	7 pcs	1 pc	
24 - 29 sq. m booth	⊙	⊙	⊙	1 pc	7 pcs	2 pcs	1 pc	2 pc	1 pc	○	9 pcs	2 pcs	
30 - 35 sq. m booth	⊙	⊙	⊙	2 pcs	9 pcs	3 pcs	2 pcs	3 pcs	1 pc	1 pc	12 pcs	3 pcs	

⊙ The equipment is present at the stand
 ○ The equipment is missing on the stand

If you are not satisfied with the standard layout or the size of your stand exceeds 35 sq.m, fill in the Form B6 please

SYMBOLS

- Fascia Panel H=0,3m
- Wall Panels H=2,5m
- Sliding door
- Office Table, Round
D=80cm., H=75cm, Chair
- Information counter
h=1,0 m, with 1 shelf
- Podium table 0,5x1,0 m
h=0,75 m, Octanorm
- Shelving, 3 shelves
h=2,5m, Octanorm
- Coat rack, Wall mounted
- Waist Basket
- Spot light (100W)
Socket 220V, 1000W

A

B

C

D

E

G
MAX